

Glat fylding

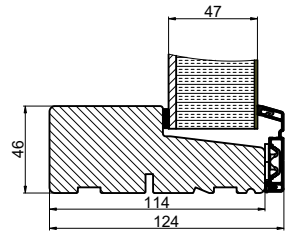

Fuldisoleret fylding med glat fylding udvendig

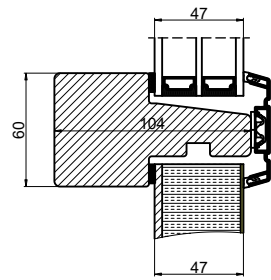
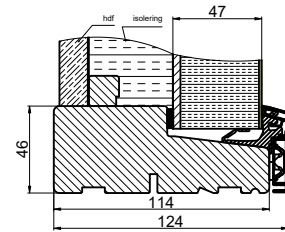
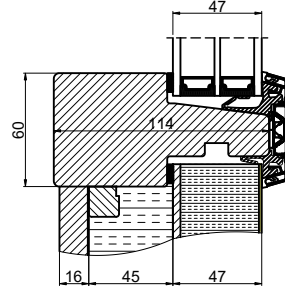

Fuldisoleret fylding med glat fylding udvendig 184 mm karm

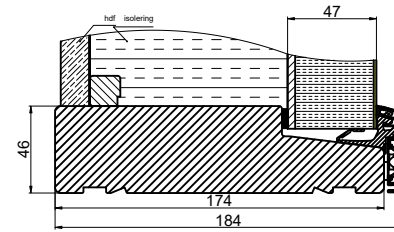
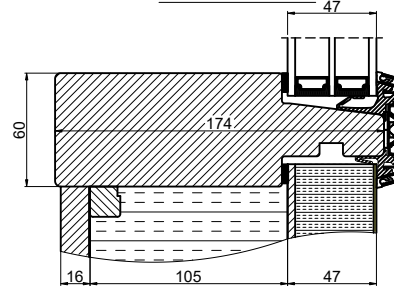

Emalit glas

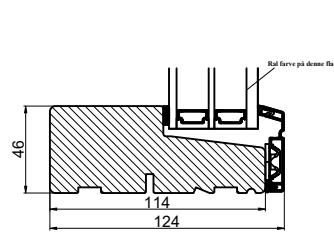
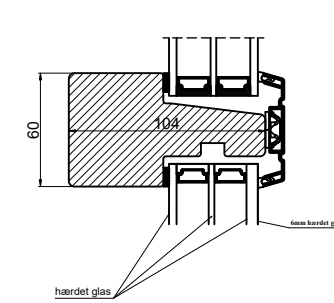

Brystningsfylding ALU/HDF

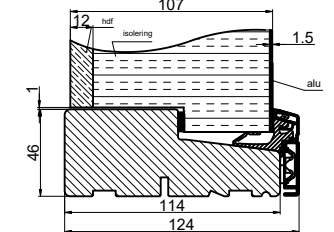
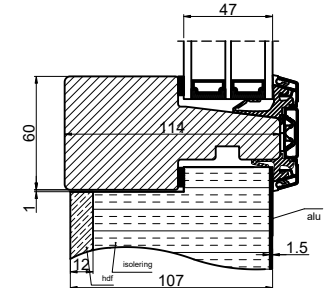

Fylding indvendig

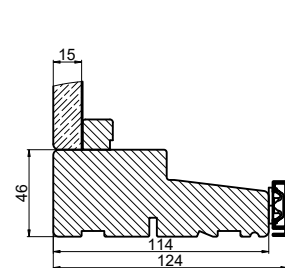
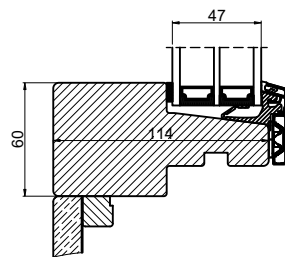

Fuldisoleret fylding med eternit panel udvendig

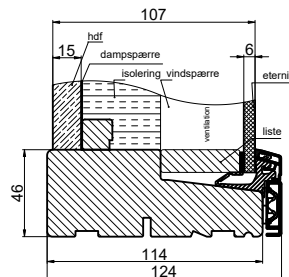
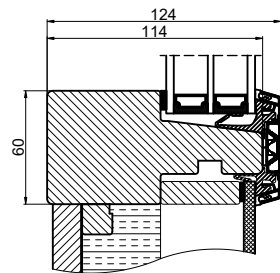

Fuldisoleret fylding med emalit glas udvendig

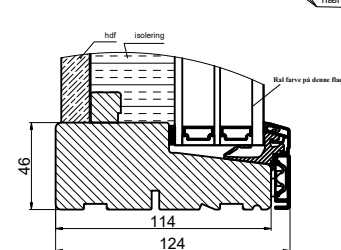
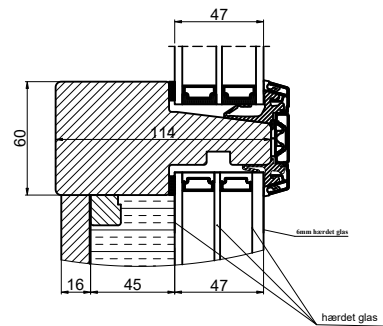

 Outline vinduer til tiden		Outline Vinduer A/S Fabriksvej 4 DK-9640 Farsø www.outline.dk	
		Tegn. nr.	994-02
Int.			MINPAU
Rev. nr.			01
Rev. dato.			2022-05-26
Benævnelse:  TRÆ / ALU 3-lags Snit af fyldinger.			